

Bucket Code 121076
Lid Code 221045
Handle Code

Technical Data Sheet
ŞEKEROĞLU 1300 ML

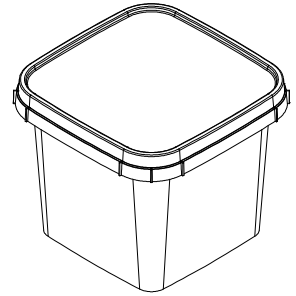
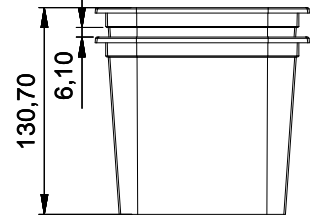
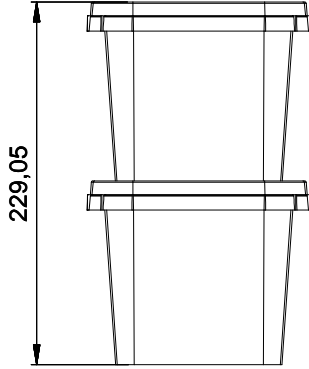
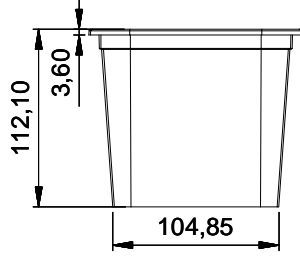
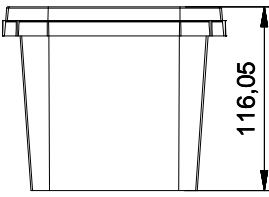
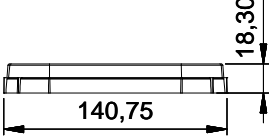
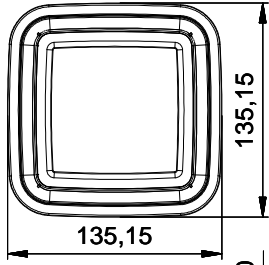

The measurements are given in mm

VOLUME	DIMENSIONS	TOLERANCE	WEIGHT
Volume Under Lid ML Brimfull 1300 ML	External diameter top without lid 135,15X135,15 External diameter bottom 104,85X104,85 Standart height 112,10 Height of lid 18,30 Height of body +lid 116,05	Dimensions ± 1 mm Volume ± 1 % ml Weight ± 5 % gr	Weight pail 42,00g Weight standart lid 20,00 g Weight handle g Total weight 62,00 g

DECORATION (Applied Decoration)

IML OFSET Body Sleeve

RAW MATERIAL

Raw Materials Options %100 PP
Masterbatch Colors %100 PP and PE based masterbatch

APPROVALS

Ministry of Agriculture and Rural Affairs with the permission of Turkish food is produced in accordance with legislation dated 11.04.2013 and with registration number of TR-42-K-004485.

DURABILITY

STORAGE AND STACKABILITY CONDUTIONS

Stackability and shipping tests have been performed as stated above at 23 C over in certain periods, in dry conditions, based on the maximum weights of standart Stackability and shipping status should be taken into account the Products characteristic. (transparent, standart, soft)
Stackability depends on many factors and the above data is meant as an indication only

PACKAGING

20' ft container	20' ft container	40' HC container	40' HC container	Truck 13600 cm	Truck 13600 cm
Pallet Dimensions: 800X1200 mm On pallet bucket quantity On pallet lid quantity 20'ft Container quantity		Pallet Dimensions: 800X1200 mm On pallet bucket quantity On pallet lid quantity 40 HC container quantity		Pallet Dimensions: 800X1200 mm On pallet bucket quantity On pallet lid quantity Truck quantity	

PERFORMANCE

HOT FILLING	Material which selected for hot filling has a very good heat resistance and suitable for hot filling Plastic Packaging become flexible when subjected to hot filling temperatures and care must be taken in relation to stacking immediately after hot filling conditions Plastic Packaging products should be cool to reach the appropriate stacking strength, after cooling of the product and pail its original stacking strenght
IN COLD WEATHER	The standart raw material for white and transparent Products resists temperatures down to -20 C. Deep frezing below -20 C may require a special raw material available on request
SHELF LIFE	The compliance of the Products to the technical specifications in this data sheet is guarenteed for 12 months after the date of the delivery The Packaging Products should be kept in suitable storage include in a dry place without direct sun light and does not exceed the viability of stacking over a long period
QUALITY INFORMATION	Our production has strict management of quality and hygiene which monitored and evaluated regularly by the Turkish Standart institute. All our Products are suitable for food stuffs Packaging

INFORMATION OF ALLERGEN
Does not contain allergen

CERTIFICATES



121076-221045 (1,1 LT) Döküman No:TÜT-00 Yayın Tarihi : 05.03.2018 Revizyon Tarihi/No: (

Our products are protected under the Turkish Patent Institute (TPE), all the specifications of the products can be changeable without the need for any permission and informed by ŞEKEROĞLU KİMYA VE PLASTİK SAN. VE TİC. A.Ş. only.
2018 / KONYA / TURKEY / SEKEROGLU

444 42 71

www.sekeroglu.com.tr